



# X2 Series Laboratory Balances





# X2 Series Laboratory Balances

The X2 series is a synergy between solutions typical for advanced class balances and technology intended mainly for professional devices.

The combination of the above qualities provides you with a high-tech instrument offering the utmost accuracy and maximum comfort of operation for a price typical of lower class devices.

- 5" color capacitive touchscreen
- Display customization via widgets
- Multilingual, interactive menu
- Sensors for touch-free operation
- Conformity with GLP and GMP regulations
- Dynamically controlled sample weight (bar graph)
- Statistics, formulations, reports and printouts
- Unlimited communication possibilities
- Alibi memory with record of measurements
- Complex databases
- Maximum comfort of operation
- Internal adjustment (excluding MA X2.A)

## Home screen

- A** Set working mode and profile
- B** Logged-in user info
- C** Date, time, connection, battery state etc.
- D** Weighing result window
- E** Load bar graph
- F** Checkweighing bar graph (thresholds)
- G** Ambient conditions pictograms
- H** Configurable additional information field
- I** Quick access buttons (editing option)
- J** Proximity sensors (operation optimization)





### AS X2 PLUS Analytical balances

Maximum capacity [Max]: up to 520 g  
 Readability [d]: down to 0.01 mg  
 Weighing pan dimensions: ø 90 mm, ø 100 mm, ø 85 mm (option)



### PS X2 Precision balances

Maximum capacity [Max]: up to 10.1 kg  
 Readability [d]: down to 1 mg  
 Weighing pan dimensions: 128 × 128 mm, 195 × 195 mm



### WLC X2 Precision balances

Maximum capacity [Max]: up to 21 kg  
 Readability [d]: down to 1 mg  
 Weighing pan dimensions: 128 × 128 mm, 195 × 195 mm, ø100 mm



### MA X2.A, MA X2.IC.A Moisture analyzers

Maximum capacity [Max]: up to 210 g  
 Readability [d]: down to 0.1 mg  
 Weighing pan dimensions: ø 90 mm, h = 8 mm



# The X2 series as a standard for quality

## Accuracy in any temperature

Accuracy is one of the most significant parameters influencing metrological characteristics of the weighing device. Production and control of X2 balances include monitoring and adjustment of accuracy in changeable temperatures. With minimized indication deviation, the X2 series ensures great measurement stability for a wide temperature range.

## Accuracy in any conditions

The multi-shield mechanical design of X2 series balances offers effective protection against the influence of ambient conditions. With such design, the X2 series ensures fast and reliable measurement of both light and heavy loads, even when ambient conditions pose challenge.

## Accuracy of each weighing indication

X2 series balances with an automatic adjustment system, using an internal adjustment weight, guarantee reliable measurement. Regardless of ambient conditions, the system provides effective elimination of any balance sensitivity deviations.

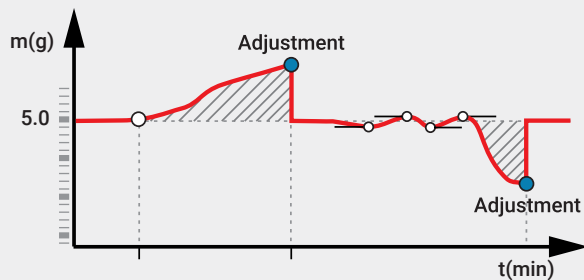

## Quality begins with precision

The optimization of X2 structural components provides measurement repeatability – the pivotal parameter for several analytical processes.

## Speed, operation time optimization

The X2 series is a product of both measuring system development and progress when it comes to the methodology of measuring signal monitoring. X2 balances offer a wide range of settings. This provides the right sensitivity for measurements performed within a very short time.

## Ambient conditions monitoring

Information on change in ambient conditions is essential in measuring devices of high resolution. For your comfort, X2 series balances have been equipped with system that signals the dynamics of temperature changes with a special symbol. This is especially useful while installing your device (acclimatization period), and when the

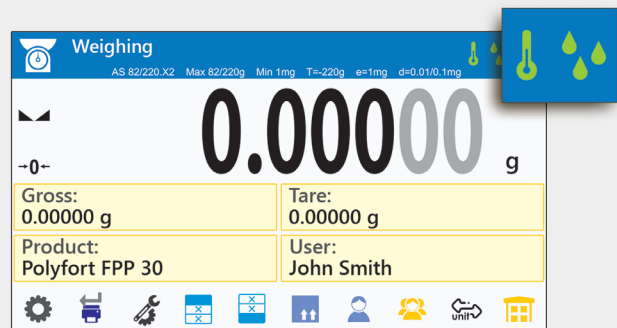

## Databases - weighing process ergonomics

The IT structure of X2 series balances is based on structural databases. Freely programmed database content favours the creation of a dedicated information network, suiting precisely the nature of any performed process. Databases comprise the following components:

- 100 users
- 100 packaging types
- 100 warehouses
- 100 formulations
- 200 formulation reports
- 500 density reports
- 1 000 customers
- 5 000 products
- 50 000 weighings
- 500 000 ALIBI records

# Redefined functionality

## Button customization

Pozwalają na szybką i pewną organizację procesu ważenia poprzez wybór jednostek miary, opakowań, klientów, zmiennych wartości tary. Dzięki indywidualnej konfiguracji zestawu przycisków, można je powiązać z konkretnym trybem pracy.

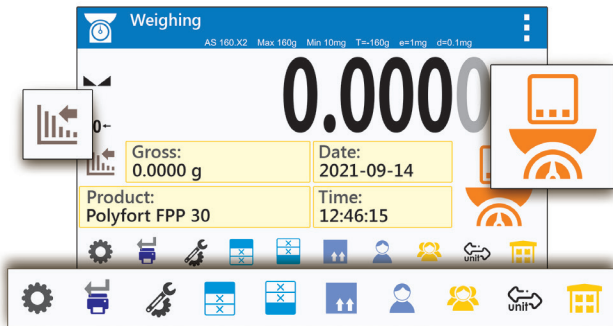

## Clear information arrangement, even greater ease of operation

Priority for our X2 series balances is ease of operation and intuitive communication with the user. Clear information presented by symbols provides even more user-friendly operation.

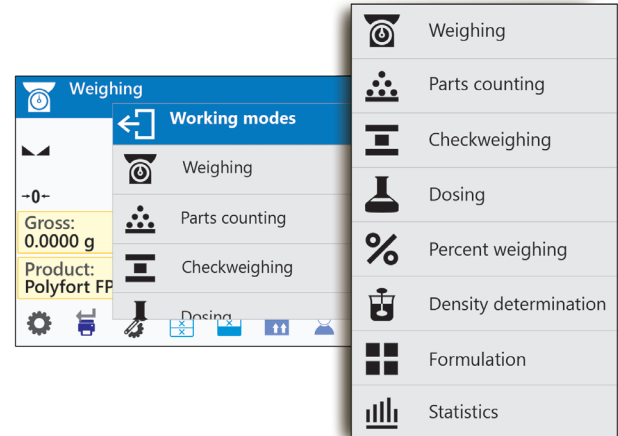

## Labels selcted freely by a user

X2 balances feature labels – pre-defined information fields providing various data, e.g. product name, user, date and time or bar graph. Labels names and values are not intended for modification but it is the user who decides which labels are to be displayed.

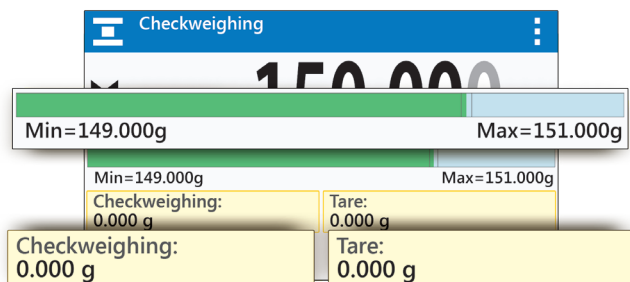

## Configurable text fields

Text fields and labels feature similar characteristics, but text fields, unlike labels, can be freely created and configured by a user. It is possible to provide each text field with an individual name, function and value. In addition, you can decide on the particular text field size and location.

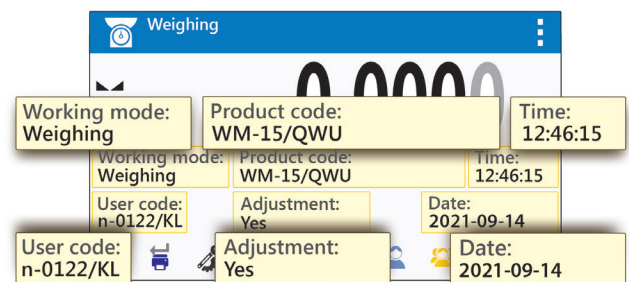

## Communication interfaces

The X2 series balances have been equipped with various means of communication. They offer standard cable connections, realized via USB-A and USB-B or RS 232 ports, and wireless connection, realised via Wi-Fi technology. The latter is supported by all RADWAG-manufactured programs.

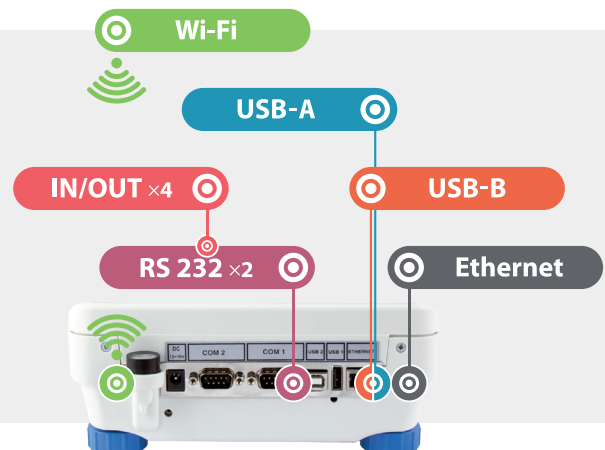

# Data safety and monitoring

## Data safety, permission levels

Three different permission levels restrict access to confidential information. It is the Administrator who manages the permission levels.

## Data archiving and exchange

The USB interface facilitates transfer of reports on processes and partial weighing to peripheral devices. This is especially useful for archiving and monitoring purposes. In addition, the USB interface allows copying of input databases.

## ALIBI memory - secure storage of measurements

The ALIBI memory provides effective data protection, allowing up to 500,000 weighings to be stored. This guarantees the security and continuity of your vital data stored over a long period of time.

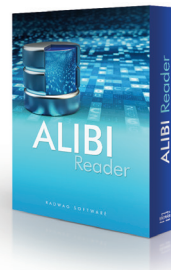

ALIBI Reader PC software enables the user to preview all weighings recorded in balance memory. The software allows printout of selected data and creation of PDF and CSV (Excel) reports.

# Reports and printouts

## Customized reports

X2 series balances offer reports comprising three customized sections. As a user you have the green light for free modification of each section content.

Working mode	Weighing
Date	18.01.2021
Time	11:36:36
Balance type	AS X2
Balance ID	2035
Product	PILL
User	John Smith
Net weight	0.8020 g
Tare	0.5000 g
Gross weight	1.3010 g
----- Calibration Report -----	
Calibration type	Internal
User	John Smith
Project	124/SGW/2021
Date	18.01.2021
Time	12:56:10
Balance ID	1035
Calibration difference	0.0000 g
-----	
Signature	-----

## Measurement printouts sent to PC software

Measurements carried out by X2 series balance can be transferred directly to R-Lab and RAD-KEY PC software.



RAD-KEY PC Software is designed to acquire your balance data with the use of special HotKey, which is then entered into an active spreadsheet cell.



R-Lab software enables scale preview and generating both weighings and statistics graphs.

# Technical specification

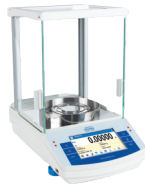

**AS X2 PLUS**



**PS X2**



**WLC X2**

Maximum capacity [Max]	60 g – 520 g	0.2 kg – 10.1 kg	0.2 kg – 21 kg
Readability [d]	0.01 mg – 0.1 mg	1 mg – 10 mg	1 mg – 1000 mg
Weighing pan dimensions	ø 90 mm, ø 100 mm, ø 85 mm (option)	128 × 128 mm, 195 × 195 mm	ø 100 mm, 128 × 128 mm, 195 × 195 mm
Stabilization time	2 s – 2.5 s	1.5 s – 2 s	2 s – 4 s
Adjustment	Internal	Internal	Internal
Display	5" colour capacitive touch screen	5" colour capacitive touch screen	5" colour capacitive touch screen
Communication interfaces	2×RS232, USB–A, USB–B, Ethernet, Wi-Fi®	2 × RS 232, USB–A, USB–B, Ethernet, Wi-Fi®	2 × RS 232, USB–A, USB–B, Ethernet, Wi-Fi®

Wi-Fi® is a registered trademark of Wi-Fi® Alliance



**MA X2.A, MA X2.IC.A\***

Maximum capacity [Max]	50 g – 210 g
Readability [d]	0.1 mg – 1 mg
Weighing pan dimensions	ø 90 mm, h = 8 mm
Moisture content readability	0.0001 % – 0.001 %
Drying temperature range	max 160°C, max 250°C (option)
Adjustment	External, Internal*
Heating module	R emitter, halogen (option), metal heater (option)
Display	5" colour capacitive touch screen
Communication interfaces	RS 232, USB–A, USB–B, Ethernet, Wi-Fi®
Automatically open drying chamber	YES

Wi-Fi® is a registered trademark of Wi-Fi® Alliance

## Optional equipment

- Barcode readers,
- PCL printers,
- USB keyboard,
- PC Software: R-Lab, RAD KEY and Alibi Reader,
- Under-pan weighing rack,
- Anti-vibration tables,
- Draft shield,
- LCD WD-6 display,
- Density determination kit for solids and liquids.

Optional equipment accessibility is conditioned by a particular model.

## Software

- R-Lab - Scales preview, weighing and statistics graphs.
- RAD KEY - Capturing balance data, inserting the data into a spreadsheet cell.
- Alibi Reader - Capturing balance data recorded in ALIBI memory.

Read QR code and view the complete technical specification of all balances and scales







[www.radwag.com](http://www.radwag.com)